

LINGXIAO®

Variable Speed Pumps Instruction Manual



Relaax130-VS



Relaax220-VS



Relaax390-VS

**READ CAREFULLY AND FOLLOW
THIS INSTRUCTION
KEEP THIS INSTRUCTION FOR
FUTURE REFERENCE**

TABLE OF CONTENTS

Important Warning and Safety Instructions -----	1~2
Overview -----	3
Pump Features	3
Drive Overview	3
Keypad Overview -----	4
Installation -----	5
Location	5
Piping	5
Fitting and Valves	5
Electrical Installation	5
Wiring Position -----	5
Wiring position	6
Grounding	6
Bonding	6
External Control Via RS485 Signal Cable -----	7
RS485 signal cable connection	7
Operation -----	8
Setting the Clock	8
Programming an Operation Schedule	8
1. Program Speed and Running time in Auto Mode	8
2. Set priming, Quick clean & exhaust time and speed	8
3. Switch from Auto Mode to Manual Mode	8
Reset factory default setting	9
Lock / Unlock the keyboard	9
Turn off/ turn on button sound	9
Button cell replacement	9
Priming	9
Maintenance -----	10
Cleaning the pump strainer & skimmer basket	10
Winterizing	10
Pump care	10
Restart the pump	10
Troubleshooting -----	11
Installation Diagram and Technical Data -----	12
Performance Curve and Installation Size -----	13
Warranty & Contact Us -----	14

IMPORTANT WARNING AND SAFETY INSTRUCTIONS

ALARM Installer: This manual offers important information about the installation, operation, and safe use of this pump. This manual should be given to the owner and/or operator of this pump after installation or left on or near the pump.

ALARM User: This manual provides important information that will help you in operating and maintaining this pump. Please keep it for future reference.

Please read and follow all instructions below.



Please pay attention to the below symbols. When you meet them in this manual or on your system, please be careful for the potential personal injury.



DANGER Cautions hazards which can lead to death, serious personal injury, or major property damage if ignored.



WARNING Cautions hazards which can lead to death, serious personal injury, or major property damage if ignored.



CAUTION Cautions hazards which can lead to death, serious personal injury, or major property damage if ignored.

NOTE

Special instructions that are not related to hazards are indicated.

All safety instructions in this manual and on equipment should be carefully read and followed. Make sure safety labels are in good condition, replace them if they are damaged or missing.

The following basic safety precautions should always be followed when installing and using this electrical equipment:



DANGER SERIOUS BODILY INJURIES OR DEATH CAN RESULT FROM FAILURE TO FOLLOW ALL INSTRUCTIONS. BEFORE USING THIS PUMP, POOL OPERATORS AND OWNERS SHOULD READ THESE WARNINGS AND ALL INSTRUCTIONS IN THE OWNER'S MANUAL. A POOL OWNER MUST KEEP THESE WARNINGS AND THE OWNER'S MANUAL.



WARNING Children are NOT allowed to use this product.



WARNING BEWARE OF ELECTRICAL SHOCK. In order to prevent a ground fault from occurring in this unit, a ground fault circuit interrupter (GFCI) must be installed on its supply circuit. The installer should install an appropriate GFCI and test it regularly. When you press the test button, the power supply should be interrupted, and when you press the reset button, the power should return. If this is not the case, the GFCI is defective. It is possible that an electric shock may occur if the GFCI interrupts power to a pump without the test button being pressed. Unplug the pump and contact a qualified electrician to replace the GFCI. Never use a pump with a defective GFCI. Always test the GFCI before use.



CAUTION Unless otherwise noted, this pump is intended for use with permanent swimming pools and hot tubs and spas if they are appropriately marked. It should not be used for storable pools.

General Warnings:

- Never open the enclosure of the drive or motor. This unit has a capacitor bank that retains a 230 VAC charge even if the power is off.
- There is no submersible feature on the pump.
- Pump high flow rate performance will be limited by older or questionable equipment when installed and programmed.
- Depending on the country, state, and local municipality, there may be differing requirements for electrical connections. Follow all local codes and ordinances as well as the National Electrical Code when installing equipment.
- Disconnect the main circuit of the pump before servicing it.
- Unless supervised or instructed by a person responsible for their safety, this appliance is not intended for use by individuals (including children) with reduced physical, mental, or sensory abilities, or without experience and knowledge.



DANGER HAZARDS RELATED TO SUCTION ENTRAPMENT: stay away from all suction outlets and the main drain! In addition, this pump is not equipped with a safety vacuum release system (SVRS) protection. In order to prevent accidents, please prevent your body or hair from being sucked by the water pump inlet.

At the main water line, the pump produces a strong vacuum and a high level of suction. Adults and children can be trapped underwater if they are near drains, loose or broken drain covers or grates. A swimming pool or spa covered with non-approved materials or one with a missing, cracked, or broken cover can cause limb entrapment, hair entanglement, body entrapment, evisceration, and/or death.

There are several causes of suction at drains and outlets:

Limb Entrapment: A mechanical bind or swelling occurs when a limb is sucked into an opening. Whenever there is a problem with a drain cover, such as a broken, loose, cracked or improperly fastened one, this hazard occurs.

Hair Entanglement: The tangle or knotting of the swimmer's hair in the drain cover, resulting in the swimmer being trapped underwater. When the flow rating of the cover is too low for the pump or pumps, this hazard may arise.

Body Entrapment: When a portion of the swimmer's body is trapped under the drain cover. When the drain cover is damaged, missing, or not rated for the pump, this hazard arises.

Evisceration/Disembowelment: A suction from an open pool (usually a child's wading pool) or spa outlet causes severe intestinal damage to a person. This hazard is present when the drain cover is missing, loose, cracked, or not properly secured.

Mechanical Entrapment: When jewelry, swimsuit, hair decorations, finger, toe or knuckle is caught in an opening of an outlet or drain cover. If the drain cover is missing, broken, loose, cracked, or not properly secured, this hazard exists.

NOTE: THE PLUMBING FOR SUCTION MUST BE INSTALLED IN ACCORDANCE WITH THE LATEST LOCAL AND NATIONAL CODES.



WARNING IN ORDER TO REDUCE INJURY RISKS FROM SUCTION ENTRAPMENT HAZARDS:

- Each drain must be equipped with an ANSI/ASME A112.19.8 approved anti-entrapment suction cover.
- Each suction cover should be installed minimum three (3') feet apart measuring between the closest points.
- Check all covers for cracks, damage, and advanced weathering regularly.
- Replace a cover if it becomes loose, cracked, damaged, broken, or missing.
- Replace drain covers as necessary. Drain covers deteriorate over time due to exposure to sunlight and weather.
- Avoid getting close to any suction cover, pool drain, or outlet with your hair, limbs, or body.
- Suction outlets can be disabled or reset into return inlets

LINGXIAO Technical Support Center:

Please visit www.lingxiaopumps.com or contact us by Phone/WhatsApp: +1 647 800 0468

IMPORTANT WARNING AND SAFETY INSTRUCTIONS

⚠ WARNING A high level of suction can be generated by the pump in the plumbing system's suction side. The high level of suction can pose a threat to those in close proximity to the suction openings. This high vacuum can cause serious injuries or cause people to become trapped and drown. Swimming pool suction plumbing must be installed according to the latest national and local codes.

⚠ WARNING A clearly identified emergency shut-off switch for the pump should be located in a highly visible location. Ensure that all users know where it is located and how to use it in case of an emergency.

The Virginia Graeme Baker (VGB) Pool and Spa Safety Act establishes new requirements for commercial swimming pool and spa owners and operators.

On or after December 19, 2008, commercial pools and spas must use: A multiple main drain system without isolation capability with suction outlet covers complying with ASME/ANSI A112.19.8a Suction Fittings for Swimming Pools, Wading Pools, Spas, and Hot Tubs and either:
(1) Safety vacuum release systems (SVRS) that meet ASME/ANSI A112.19.17 Manufactured Safety Vacuum Release systems (SVRS) for Residential and Commercial Swimming Pools, Spas, Hot Tubs, and Wading Pool Suction Systems, or ASTM F2387 Standard Specification for Manufactured Safety Vacuum Release Systems (SVRS) for Swimming Pools, Spas and Hot Tubs
(2) Suction-limiting vents that have been properly designed and tested
(3) System for shutting off pumps automatically

Pools and spas constructed before December 19, 2008, with a single submerged suction outlet, must use a suction outlet cover that meets ASME/ANSI A112.19.8a or either:
(A) A SVRS compatible to ASME/ANSI A112.19.17 and/or ASTM F2387, or
(B) Suction-limiting vents that have been properly designed and tested or
(C) System for shutting off pumps automatically, or
(D) Submerged outlets can be disabled or
(E) Reconfiguration of suction outlets into return inlets is required.

⚠ CAUTION Installing electrical controls at the equipment pad (ON/OFF switches, timers, and automation load centers)
Ensure that all electrical controls are installed at the equipment pad, including switches, timers, and control systems. To prevent the user from putting his/her body over or near a pump strainer lid, filter lid, or valve closure when starting, shutting down, or servicing a pump or filter. During system start-up, shutdown, or servicing of the filter, the user should be able to stand far enough away from the filter and pump.

⚠ DANGER When starting up, keep the filter and pump away from your body.
When parts of a circulating system are serviced (i.e. locking rings, pumps, filters, valves, etc.) air can enter and pressurize the system. It is possible for the pump housing cover, filter lid, and valves to violently separate when subjected to pressurized air. You must secure the strainer cover and filter tank lid to prevent violent separation.
When turning on or starting up the pump, keep all circulation equipment clear of you. You should note the filter pressure before servicing the equipment. Make sure that the pump controls are set so that it cannot start inadvertently during service.

IMPORTANT: Ensure that the filter manual air relief valve is in the open position and wait for all pressure in the system to be released. Open the manual air relief valve fully and put all system valves in the "open" position before starting the system. Make sure you stand clear of any equipment when starting the system.
IMPORTANT: If the filter pressure gauge is higher than the pre-service condition, don't close the manual air relief valve until all pressure has been released from the valve and a steady stream of water appears.

Information about Installation:

- There is a requirement that all work be performed by a qualified service professional and in accordance with all national, state, and local regulations.
- Ensure that electrical components are properly drained in the compartment.
- There are several models of pump included in these instructions, so some may not apply to a specific model. All models are geared toward swimming pool use. If the pump is properly sized for the specific application and properly installed, it will function correctly.

⚠ WARNING The improper size, installation, or use of pumps in applications for which they were not designed can result in serious personal injury or death. There are a number of risks involved, including electric shocks, fires, flooding, suction entrapment, severe injury to others or property damage as a result of structural failures in pumps or other system components.

Pumps and replacement motors that are single speed and one (1) Total HP or greater cannot be sold, offered for sale, or installed in a residential pool for filtration use in California, Title 20 CCR sections 1601-1609.

OVERVIEW

Pump Features:

- Energy Star 3.1, DOE, CEC Certified.
- Larger strainer basket with transparent pot lid for easy inspection.
- Handle for easy carrying.
- Super quiet operation as low as 42 decibels.
- ANSI standard fittings (1.5" OR 2").
- Quick & easy operation for In ground Self-priming pumps (Relaax220-VS & Relaax390-VS) & above ground swimming pool pump (Relaax130-VS).
- Programable operation schedule to save energy consumption up to 80%.
- NSF 50 Certified for Relaax220-VS, Relaax390-VS.

Drive Overview:

The pump is equipped with a variable speed, high efficiency motor that provides flexibility in terms of motor speed. There are settings for duration and intensity. Pumps are designed to run continuously maintaining a sanitary environment at the lowest possible speed, minimizing the consumption of energy while protecting the environment.



Pump is rated for 115/208-230 Volts nominal, Only for pool pumps. Connecting incorrect voltage or use in other applications may cause damage, personal injury or damage to equipment.

The integrated electronics interface controls the speed and the duration of the run. The pumps can operate at speeds ranging from 450 to 3450 revolutions per minute (RPM). The pump is designed to operate within the voltage range of 115/280-230 volts at either 50 or 60Hz input frequency.

It is usually best to set the pump to the lowest setting possible in order to minimize energy consumption; the fastest speed for the longest duration leads to more consumption of energy. However, the optimal settings can be influenced by a number of factors, such as the size of the pool, environmental conditions and the number of water features. Pumps can be programmed according to adapt to your specific needs.

Drive Features:

- User-friendly interface
- Enclosures that are UV and rain-proof
- Time schedule onboard
- Priming & Quick Clean mode can be Programmed
- Display and retention of pump alarms
- Power input: 115/208-230V, 50 & 60Hz
- Power limiting protection circuit
- A 24-hour service is available. In case of power outages, the clock will be retained
- Lockout mode for the keypad

KEYPAD OVERVIEW

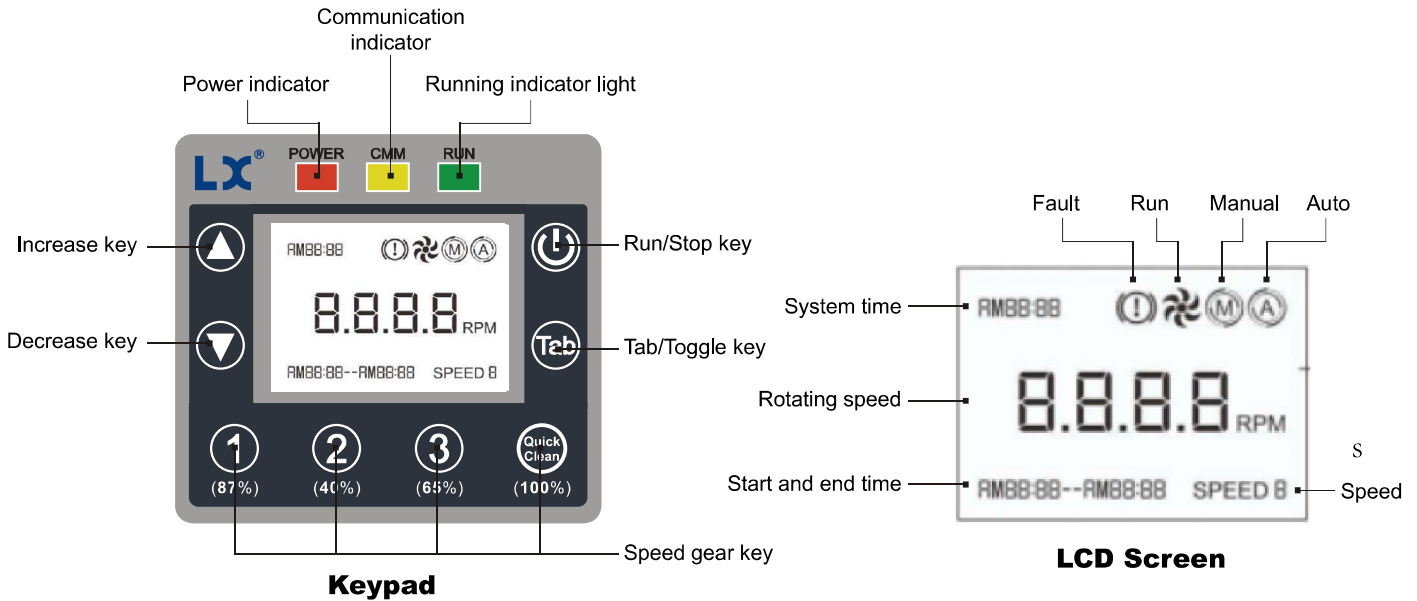

! WARNING If power is connected to the motor, it is important to be aware that pressing any of the buttons referred to in this section could result in the motor starting. This could lead to potential danger in the form of personal injury or damage to equipment if the risk is not taken into account.

Key symbol	Name	Function Description
	Run/Stop key	Control the start-up and shutdown of the pump.
	Speed gear key	① In automatic mode, you can check the speed gear. ② In manual mode, the speed gear can be selected. ③ Press and hold the button for 3 seconds to enter the setting state, press Tab / / , set speed and running time (running time can only be set in automatic mode []).
	Quick clean button	① In automatic mode, you can view the quick cleaning gear. ② In manual mode, the quick cleaning gear can be selected. ③ Press and hold the button for 3 seconds to enter the setting state, press Tab / / , set speed and running time (running time can only be set in automatic mode []) [NOTE 1] .
	Tab/toggle key	① Display running wattage. ② In the setting state, you can select speed, time (hour, minute) in turn. ③ Press and hold the button for 3 seconds to enter the system time setting.
	Increase key	Speed increase/time increase.
	Decrease key	Speed reduction/time reduction.
	Key combination	In the off state, press the Tab + button at the same time and hold for 3 seconds to restore the factory settings.
		In the off state, press and hold the Tab + buttons for 3 seconds at the same time, the LCD screen will switch between manual mode and automatic mode, and the corresponding icon will be displayed.
	Key combination	The controller displays the home page, and press the Tab + key for 3 seconds at the same time to lock/unlock the keyboard.
		The controller displays the home page, press the Tab + button for 3 seconds at the same time to turn on/off the button sound.

NOTE 1:
 Every time when the pump is started, it will run at a speed of 3450r/min for 10 minutes (the factory default is 3450r/min, 10min), and the home page of the screen will display a countdown. After the countdown ends, it will run according to the predetermined plan when in auto mode or perform manual operation;
 In the Auto Mode, hold button for 3 seconds, speed number(3450) will blink and use / to set priming speed; Then press **Tab** button and the priming time will blink, Then use / button to set priming time.

NOTE 2:
 In the setting state, if there is no button operation for 6 seconds, it will exit the setting state and save the settings. The operation cycle does not exceed 24 hours.

INSTALLATION

INSTALLATION:

It is essential to only use a qualified professional to ensure a safe and successful installation. Failure to follow this instruction correctly could result in serious injury or property damage.

LOCATION:

NOTE: It is important to note that when installing this pump, it should not be placed within an outer enclosure or underneath the skirt of a hot tub or spa, unless it is marked accordingly.

Note: it is essential to ensure that the pump is mechanically secured to the equipment pad for proper functioning.

Make sure the pump can match the below requirements:

1. It is important to install the pump as close to the pool or spa as possible. This will reduce friction loss and improve the overall efficiency of the pump. To further reduce friction loss and improve efficiency, it is recommended to use short, direct suction and return piping.
2. It is important to ensure that there is a minimum of 5' (1.5 m) between the inside wall of the pool and spa and any other structures. For any Canadian installations, a minimum of 9.8' (3 m) from the inside wall of the pool must be maintained.
3. It is important to install the pump at least 3' (0.9 m) away from the heater outlet.
4. It is important to remember to not install the self-priming pump more than 8' (2.6 m) above the water level.
5. It is important to choose a well-ventilated location that is protected from excess moisture.
6. Please keep at least 3" from the rear of motor and 6" from the top of control pad for easy maintenance and repair.



PIPING:

1. The Piping diameter on the intake of the pump should be the same or larger than the one of the discharge.
2. The shorter of plumbing on the suction side is better.
3. A valve on both suction and discharge lines is recommended for easy maintenance and repair.
4. Any valve, elbow installed in the suction line should be at least five (5) times of suction line diameter from the discharge port. For example, a 2" pipe requires a 10" straight line before the suction port of the pump, as below drawing.



Fittings and Valves:

1. 90° elbows directly into pump intake & discharge are NOT allowed.
2. Installing gate valves on suction and discharge pipes is an important part of any flooded suction system, as it allows for maintenance and other activities to be carried out more easily. However, the suction gate valve should not be placed any closer than five times the diameter of the suction pipe.
3. Using a check valve in the discharge line is highly recommended for any application of this pump where there is significant plumbing height after the pump.
4. It is important to install check valves when plumbing in parallel with another pump to ensure proper functioning. Check valves help to prevent reverse rotation of the impeller and motor.

Electrical Installation:

⚠ DANGER READ THIS INSTRUCTION BEFORE OPERATION RISK OF ELECTRICAL SHOCK OR ELECTROCUTION.

It is essential that the pump MUST be installed by a qualified and licensed electrician, or a certified service professional, in accordance with the National Electrical Code and all applicable local codes and ordinances. When the pump is not properly installed, it can create an electrical hazard, which can potentially lead to death or serious injury, due to electric shock or electrocution.

It is essential to always disconnect power to the pump at the circuit breaker before servicing the pump. Failing to do so can have catastrophic consequences for those involved: Electric shock and property damage are the least of the dangers; Death or serious injury to service people, pool users, or even bystanders can occur.

The pump can automatically accept a single phase, 115/208-230V, 50 or 60 Hz input power and No wiring change is required. The power connections (below picture) are capable of handling up to 10 AWG solid or stranded wire.

WIRING POSITION

1. Use a Phillips screwdriver to loosen the 4 screws and open the cover. Please open it slowly to prevent damage to the wiring at the connection between the control panel and the circuit board.



2. Find the reserved wiring terminals on the circuit board.

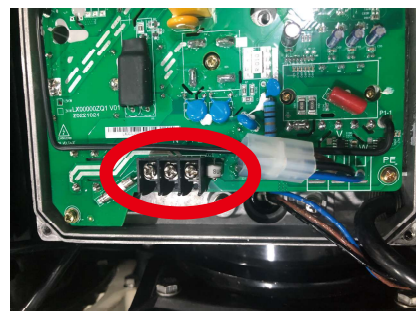

WIRING POSITION

Wiring Position:

For 115V/60HZ input:

Terminal **L** (Live Wire), Terminal **N** (Neutral Wire), Terminal **G** (Ground Wire). This applies to Relaax130-VS & Relaax220-VS.

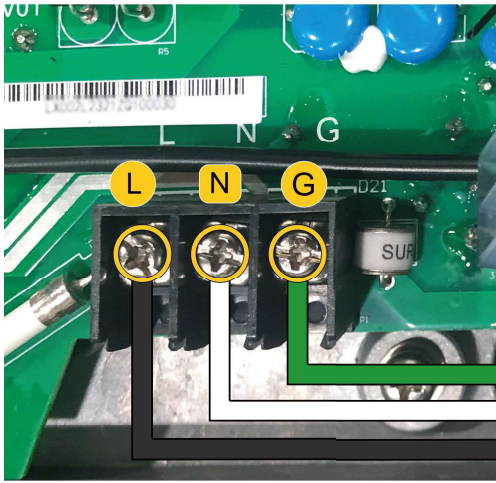

For 208-230V/60HZ input:

Terminal **L1** (Live Wire 1), Terminal **L2** (Live Wire 2), Terminal **G** (Ground Wire). This applies to Relaax220-VS & Relaax390-VS.

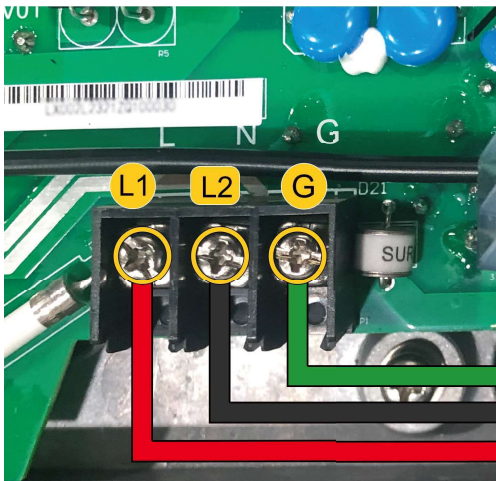

For 208-230V/50HZ input

Terminal **L** (Live Wire), Terminal **N** (Neutral Wire), Terminal **G** (Ground Wire). This applies to Relaax220-VS & Relaax390-VS.

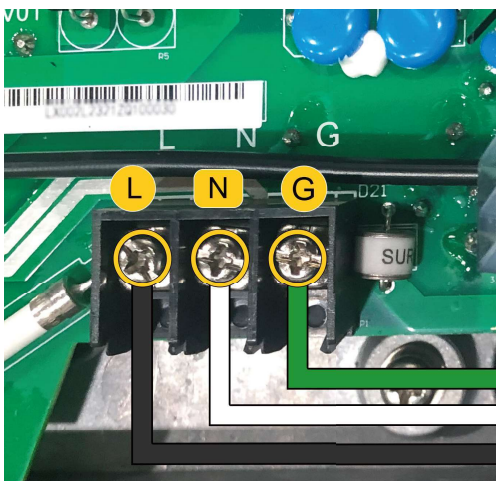

⚠ WARNING STORED CHARGE
- Wait at least 5 minutes before servicing

1. All electrical breakers and switches MUST be turned off before wiring the motor.
2. Input power MUST match the requirements on the data plate.
3. Regarding wiring sizes and general requirements, it is important to follow the specifications as defined by the current National Electric Code and any local codes. When unsure of what size wire to use, it is always best to use a heavier gauge (larger diameter) wire for safety and reliability.
4. All electrical connections MUST be clean and tight.
5. Trim the wiring to the correct size and ensure that the wires do not overlap or touch when they are connected to the terminals.
6. It is important to reinstall the drive lid after any electrical installation or whenever leaving the pump unsupervised during servicing. This is to ensure that rainwater, dust, or other foreign particles are not able to accumulate in the drive.

Note: Make sure that wires are not pinched between the drive body and lid when installing the drive.

⚠ CAUTION The power wiring cannot be buried in the ground

7. The power wiring cannot be buried in the ground, and the wires must be positioned to avoid damage from other machines such as lawn movers.
8. To prevent electric shock, damaged power cords should be replaced immediately.
9. Beware of accidental leakage, do not place the water pump in the open environment.
10. To prevent electric shock, do not use extension cords to connect to the power supply.

Grounding:

1. It is important to ensure that the motor is properly grounded using the Grounding Terminal as shown in below Figure inside the drive wiring compartment. When installing the ground wire, be sure to follow the requirements of the National Electrical Code and any local codes for wire size and type. Additionally, ensure the ground wire is connected to an electrical service ground for the best results.

2. **⚠ WARNING** WARNING electric shock hazard. This pump must be connected to a power supply with leakage protection (GFCI). GFCI systems should be supplied and inspected by the installer.

Bonding:

1. Using the Bonding Lug located on the side of the motor (Below Figure), bond the motor to all metal parts of the pool structure, electrical equipment, metal conduit, and metal piping within 5' (1.5 m) of the inside walls of the swimming pool, spa, or hot tub. This bonding should be done in accordance with the current National Electrical Code and any local codes.
2. For American installations, an 8 AWG or larger solid copper bonding conductor is required. For Canada installation, a 6 AWG or a larger solid copper bonding conductor is required.

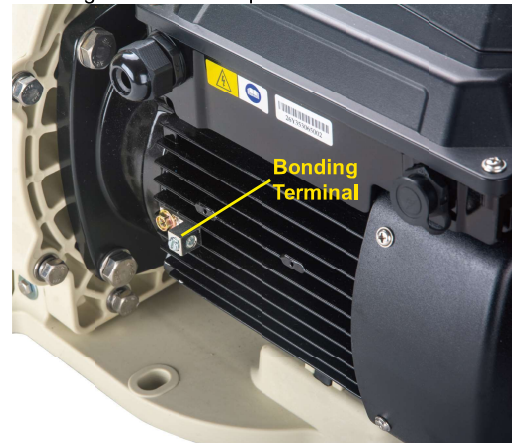

External Control Via RS485 Signal Cable

RS485 signal cable connection:

The pump can be controlled by Pentair control system via RS485 signal cable (Sold separately).

1. Please strip the cables around 3/4" (19 mm) and connect green cable to Terminal 2 and yellow cable to terminal 3 at Pentair Control system.
2. At another end of the signal cable, please connect it to the communication port of the pump and lock up the watertight nut to avoid humidity, Please look at the below diagram.

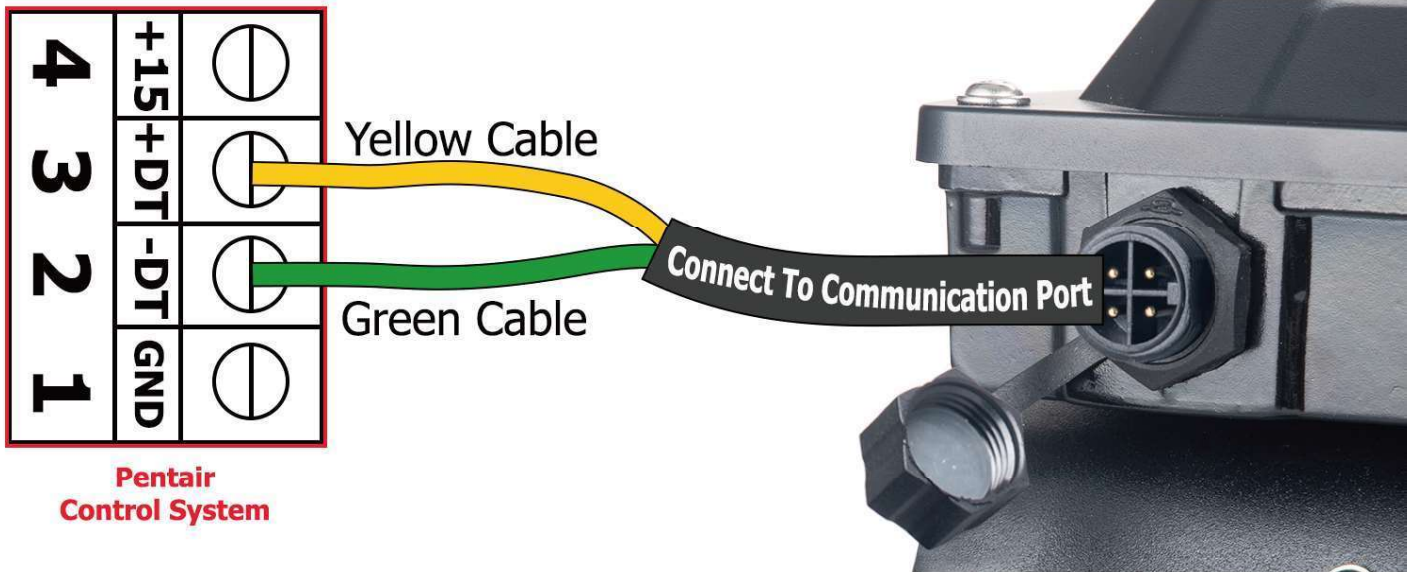

3. After successfully connected, the monitor of pump will show ECOM and the Communication indicator will be lighted up. Then, the pump gives the control right to Pentair Control System.

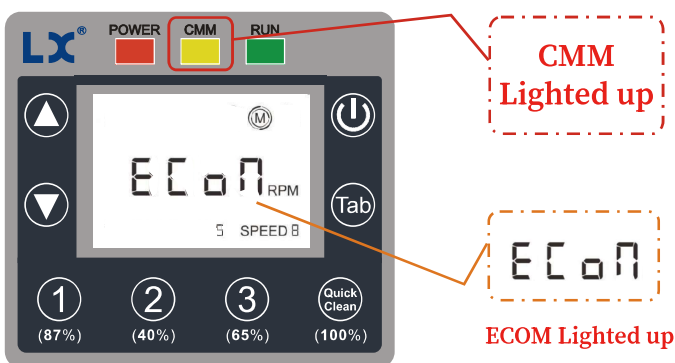

OPERATION

Setting the Clock:

Hold the **Tab** button for 3 seconds into time setting, the hour number will blink. Use **▲** / **▼** button to set hour, press **Tab** again and move to minute setting. Use **▲** / **▼** button to set minute.

Programming an Operation Schedule:

1. Turn on the power, and then the Power LED light turns on.

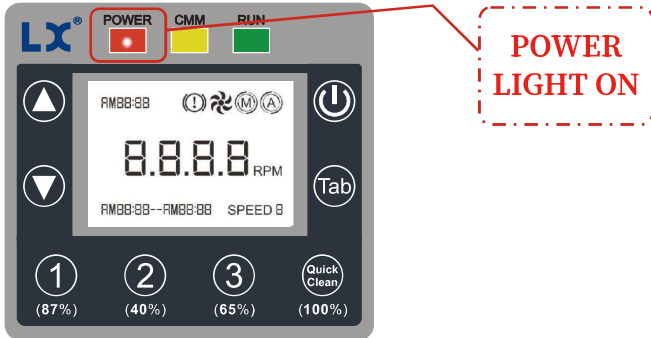

2. The Default setting is in Auto Mode and those Four speeds are running as below schedule.

Speed	Range of rotation	Factory default	Run time (factory setting)
1	300~3450rpm	3000rpm	AM 08:00~AM 10:00
2	300~3450rpm	1400rpm	AM 10:00~PM 20:00
3	300~3450rpm	2200rpm	PM 20:00~ PM 22:00
Quick Clean	300~3450rpm	3450rpm	

Set Speed and Running time in Auto Mode:

1. Hold one of the speed buttons for 3 seconds, the speed number will blink. Then, use **▲** / **▼** button to increase or decrease the speed. If no operation for 6 seconds, the speed number will stop blink and confirm the settings.
2. Hold one of the speed buttons for 3 seconds, the speed number will blink. Press the **Tab** button to switch to running time setting. The running time at the lower left corner will blink. Use **▲** / **▼** button to modify Start time. Press the **Tab** button and end time number will blink to be programmed. Use **▲** / **▼** button to modify End time. The setting process is the same for Speed 1, 2, & 3.

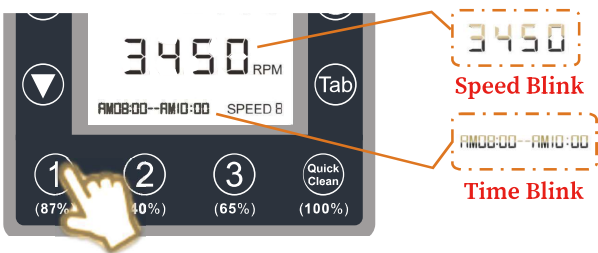

Note: Automatic Mode

The pump is designed to operate primarily in Automatic Mode. In this mode, the pump cycles through pre-programmed settings based on the configurations made for buttons 1, 2, and 3.

The quick clean button, when in auto mode, is only used to program the Duration of the priming. The quick clean button cannot activate the quick clean function when in auto mode.

Note: At any time during the day that is not within the programmed SPEED 1-3, the pump will stay in a stationary state.
[SPEED 1 + SPEED 2 + SPEED 3 ≤ 24 Hours]

Set priming time:

For self-priming in ground pool pump (Relaax220-VS & Relaax390-VS), the factory default setting is running the pump for 10 minutes at maximum speed 3450 RPM.

For Non self-priming above ground pool pump (Relaax130-VS), the factory default setting is running the pump for 1 minute at maximum speed 3450 RPM to exhaust air inside the pipe line.

In the Auto Mode, hold **Quick Clean** button for 3 seconds, speed number(3450) will blink; Then press **Tab** button, the priming time will blink; Then use **▲** / **▼** button to set priming time.

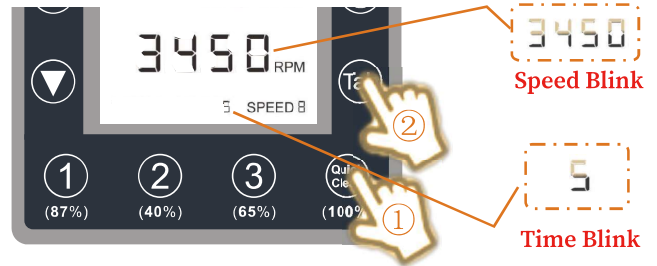

Switch from Auto Mode to Manual Mode:

The Factory Default is in Auto Mode. Hold **Tab** + **▼** for three seconds, the system will be changed from Auto Mode to Manual Mode.

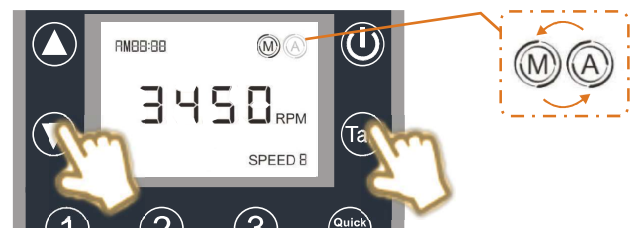

Set Speed in manual Mode:

Hold one of the speed buttons for 3 seconds, the speed number will blink. Then, use **▲** / **▼** button to increase or decrease the speed. If no operation for 6 seconds, the speed number will stop blink and confirm the settings.



Note: Manual Mode

For more control over the pump's operation, you can switch to Manual Mode. This mode allows you to set a single speed at which the pump will run continuously until you decide to change the RPM or switch back to Automatic Mode.

This mode is ideal for specific cleaning tasks or when a constant speed is preferred.

OPERATION

Reset factory default setting:

In power off situation, hold **Tab** + **▲** together for three seconds and factory default setting will be recovered.

Lock / Unlock the keyboard:

In the home page, hold **Tab** + **Quick Clean** for 3 seconds at the same time to lock/unlock the keyboard.

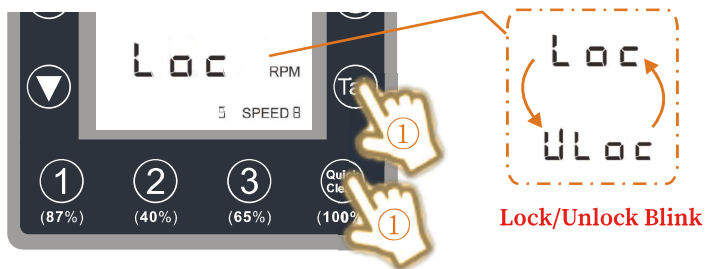

Turn off/ turn on button sound:

In the controller displays the home page, press **Tab** + **1** the button for 3 seconds at the same time, you can turn on/off the button sound.

Button cell replacement:

If power to the pump is unexpectedly cut off and later restored, the pump will automatically start its priming cycle. The controller is backed by a button cell (CR1220 3V) that lasts 2-3 years, maintaining basic functions during outages, the controller has a backup power by a button cell (CR1220 3V) which has 2~3 year life.

1. Use a Phillips screwdriver to loosen the 4 screws and open the cover. Please open it slowly to prevent damage to the wiring at the connection between the control panel and the circuit board.



2. Find Button Cell (CR1220 3V) on the circuit board, then replace it.



Priming:

CAUTION The pump is preset with priming mode for 10 minutes at 3450RMP when it starts each time.

ALARM: The pump should never run without water. Otherwise, the shaft seal is damaged and the pump starts to leak, it is essential that the seal is replaced. To avoid this, it is important to maintain the proper water level in your pool, filling it to half way up the skimmer opening. If the water falls below this level, the pump could draw in air, leading to a loss of prime and the pump running dry and causes a damaged seal, which can cause a loss of pressure, leading to damage to the pump body, impeller and seal and result in both property damage and potential personal injury.

Check before the initial startup

- Check that the shaft turns freely.
- Check whether the power supply voltage and frequency are consistent with the nameplate.
- Check for obstructions in the pipe.
- A system should be configured to prevent the pump from starting when there is no minimum water level.
- Check the rotation direction of the motor, it should be consistent with the indication on the fan cover. If the motor won't start, try to find the problem in the table of most common faults and see possible solutions.

Start

Open all valves and power on the motor, check the circuit breaker current of the motor, and adjust the overheat protector appropriately.

Turn on the power, the POWER indicator light is on, and the inverter is in the stop state. The system time and **A** icon are displayed on the LCD screen. Press the **U** key, the water pump starts or stands by, and runs at a speed of 3450r/min for 10 minutes each time it starts (Note 1). At this time, the LCD screen displays the system time, **A** icon, running icon, SPEED 4, 3450RPM and countdown of priming time; after 10 minutes of running, work according to the preset automatic mode (the system time, **A** icon, running icon, rotating speed, start and stop running time, multi-stage speed number are displayed on the screen), and the multi-stage speed is executed sequentially in chronological order (there are multiple-stage speed settings in the same time period), the running priority is: **1** > **2** > **3**), if there is no need for a multiple-stage speed, it is necessary to set the start and end time of the multiple-stage speed to be the same.

Priorities

Note: In the case of a pump that is installed below the water line of a pool, ensure that the return and suction lines are closed before opening the strainer pot on the pump. Before operating, reopen valves.

MAINTENANCE

ALARM:

It is important to be aware that if the pump fails to prime or has been operating without water in the strainer pot, it should not be opened. This is because the pump may contain a build up of vapor pressure and scalding hot water, which could result in serious personal injury if opened. To ensure safety and avoid potential personal injury, all suction and discharge valves must be opened carefully. Additionally, you should verify that the strainer pot temperature is cool to the touch before proceeding to open the valves with extreme caution.

ATTENTION:

To ensure that the pump and system remain in optimal working condition, it is important to clean the pump strainer and skimmer baskets regularly.

ALARM:

Before servicing the pump, turn off the circuit breaker. Electric shock could kill or seriously injure service workers, users, or others if this is not done. Before servicing the pump, read all servicing instructions.

Cleaning the pump strainer & skimmer basket:

It is highly recommended to check the Strainer Basket as frequently as possible to clean up the trash. The safety instruction is as follows:

1. Press Stop/ Start to stop the pump.
2. Turn off power to the pump at the circuit breaker.
3. In order to relieve all pressure from the filtration system, the filter air relief valve must be activated.
4. To remove the strainer pot lid, twist it in a counterclockwise direction.
5. Take the strainer basket out from the strainer pot.
6. Clean up the trash from Basket.

Note: If there is any cracks or damage on the basket, replace it with a new one.

7. Carefully lower the basket into the strainer pot, making sure that the notch in the bottom of the basket is aligned with the rib on the bottom of the pot.
8. The strainer pot should be filled with water up to the inlet port.
9. The lid, O-ring and sealing surface should be Cleaned carefully.

Note: Keeping the lid O-ring clean and well lubricated is essential to maintain the life and performance of the pump.

10. Install the lid onto the strainer pot and turn the lid clockwise in order to lock it securely into place.

Note: In order to properly lock the lid, the handles need to be nearly perpendicular to the pump body.

11. Turn on power to the pump at the circuit breaker.
12. Open the filter air relief valve
13. Keep away from the filter and turn on the pump.
14. To bleed air from the filter air relief valve, open the valve and let the air escape until a steady stream of water appears.

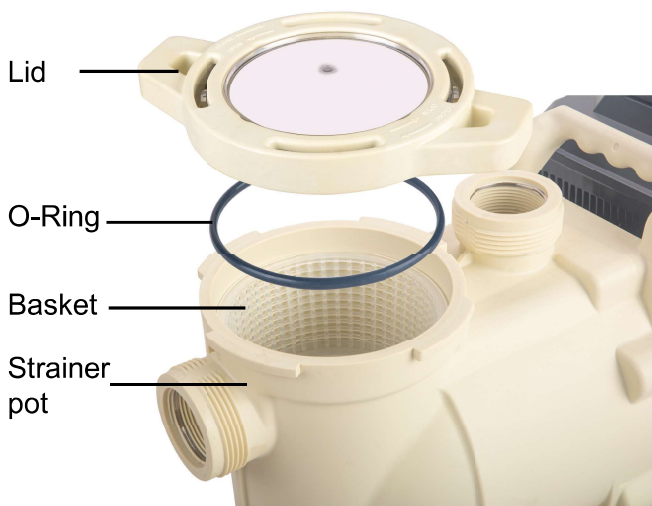

⚠ DANGER

All parts of circulation system (Lock Ring, Pump, Filter, Valves, and so on) are running under high pressure. Pressurized air can be a potential hazard because it can cause the lid to be exploded off, potentially resulting in serious injury, death, or property damage. In order to avoid this potential hazard, please follow above safety instructions.

Winterizing:

It is important to note that freeze damage is not covered under warranty. If freezing temperatures are predicted, there are steps you can take to reduce the risk of freeze damage.

1. Press Stop/ Start to stop the pump.
2. Turn off power to the pump at the circuit breaker.
3. In order to relieve all pressure from the filtration system, the filter air relief valve must be activated.
4. Carefully unscrew two drain plugs from the bottom of the strainer pot, and allow the water to drain completely. Place the drain plugs in the strainer basket for storage.
5. It is important to cover your motor when exposed to extreme weather conditions, such as heavy rain, snow and ice.

Note: Wrapping the motor with plastic or any other airtight material is prohibited. When the motor is in use, or when it is expected to be in use, MUST NOT cover the motor.

Note: In mild climate areas, it is recommended to run the equipment all night when freezing temperatures are forecast or have already occurred.

Pump care:

Avoid Over-heating

1. Shield from sun & heat
2. Well ventilated environment to avoid over-heating

Avoid messy working conditions

1. Keep working conditions as clean as possible.
2. Keep chemicals away from motor.
3. Dust should not be stirred up or swept near the motor during operation.
4. Dirt damage to the motor may void the warranty.
5. It is important to clean the lid, the O-ring, and the sealing surface of the strainer pot.

Keep away from moisture

1. Splashing or sprayed water should be avoided.
2. Flood protection from extreme weather.
3. Ensure that the pump is protected from extreme weather conditions such as flooding.
4. Let the motor internals dry before operating if they have become wet.
5. Flooded pumps should not be operated.
6. Water damage to a motor may void the warranty.

Restart the Pump

Priming the pump

1. Turn off power to the pump at the circuit breaker.
2. In order to relieve all pressure from the filtration system, the filter air relief valve must be activated.
3. To remove the strainer pot lid, twist it in a counter-clockwise direction.
4. The strainer pot should be filled with water up to the inlet port.
5. Install the lid onto the strainer pot and turn the lid clockwise in order to lock it securely into place.

Note: In order to properly lock the lid, the handles need to be nearly perpendicular to the pump body.

6. Turn on power to the pump at the circuit breaker.
7. Open the filter air relief valve.
8. Keep away from the filter and turn on the pump.
9. To bleed air from the filter air relief valve, open the valve and let the air escape until a steady stream of water appears.

When the priming cycle is complete, the pump will begin normal operation.

TROUBLESHOOTING

Faults and codes

No.	Codes	Fault description	Possible failure cause	Countermeasures
1	E001	IPM module failure	<ol style="list-style-type: none"> 1. Rising speed is too fast; 2. Power electronic components are damaged; 3. Interference causes Mis-operation; 4. Poor ground connection 	<ul style="list-style-type: none"> • Extended acceleration time • Check whether there is strong interference around • Check the ground wire • Contact the supplier
2	E002	Output current exceeds the limit	<ol style="list-style-type: none"> 1. Accelerating too fast; 2. decelerating too fast; 3. Sudden change or abnormality of load; 	<ul style="list-style-type: none"> • Extended acceleration time • Extend the deceleration time • Check the load or reduce the load sudden change
3	E006	Input voltage is too high	<ol style="list-style-type: none"> 1. Abnormal input voltage; 2. Slowing down too fast; 3. Load disconnection. 	<ul style="list-style-type: none"> • Check the input power • Increase deceleration time • Check if the load is disconnected
4	E009	Input voltage is too low	<ol style="list-style-type: none"> 1. Input voltage is low 	<ul style="list-style-type: none"> • Check input power
5	E010	Inverter overload	<ol style="list-style-type: none"> 1. Accelerating too fast. 2. The motor restarts without stopping. 3. The voltage is too low. 4. Too much load. 	<ul style="list-style-type: none"> • Increase acceleration time. • Avoid shutting down and restarting. • Check the network voltage. • Choose an inverter with higher power.
6	E011	Motor overload	<ol style="list-style-type: none"> 1. The voltage of the power grid is too low. 2. The motor stalls or the load changes suddenly. 	<ul style="list-style-type: none"> • Check the voltage. • Check the load.
7	E013	Output phase loss	<ol style="list-style-type: none"> 1. U, V, W phase loss. 2. The three-phase load is seriously unbalanced. 	<ul style="list-style-type: none"> • Check output wiring. • Check the motor and cables.
8	E014	Inverter overheating	<ol style="list-style-type: none"> 1. The air duct is blocked. 2. The ambient temperature is too high. 3. The control panel is abnormal. 	<ul style="list-style-type: none"> • Drainage channel. • Reduce the ambient temperature. • Contact suppliers and seek services.
9	E018	Faulty current sampling circuit	<ol style="list-style-type: none"> 1. The current detection element is abnormal. 2. Abnormal amplifier circuit. 	<ul style="list-style-type: none"> • Contact suppliers and seek services. • Contact suppliers and seek services.
10	E021	Display board EEPROM failure	<ol style="list-style-type: none"> 1. Bad connection between the display board and the main drive board. 2. EEPROM damage. 	<ul style="list-style-type: none"> • Replace the connecting cable between the display board and the main drive board. • Contact suppliers and seek services
11	E048	PFC over current	<ol style="list-style-type: none"> 1. The grid voltage is too low; 2. PFC circuit failure 	<ul style="list-style-type: none"> • Check the network voltage • Contact suppliers and seek services

E002 will automatically recover, and other fault codes will appear, the inverter will stop, and it needs to be powered off and on again to restart the inverter.

INSTALLATION DIAGRAM AND TECHNICAL DATA

Installation diagram

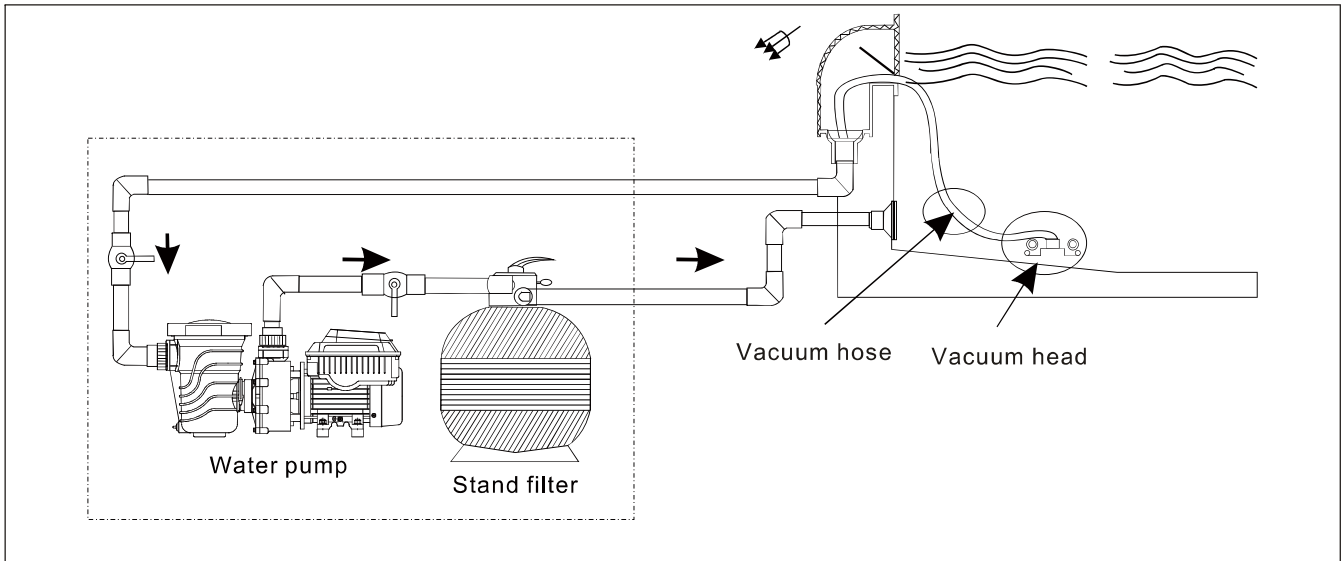

Technical Data

Model	Voltage (V)	Frequency (Hz)	Power (THP)	Current (A)	WEF	Hmax (m)	Qmax (L/min)	Speed (r/min)	G.W (Kg)
Relaax130-VS	115	50/60	1.3	12	11.3	17	330	450~3450	13.8
Relaax220-VS	115/208-230	50/60	2.2	13.8/8.5-7.4	8.8	23	510	450~3450	20
Relaax390-VS	230	50/60	3.9	13	7.3	27	650	450~3450	25.8

PERFORMANCE CURVE AND INSTALLATION SIZE

Relaax130-VS

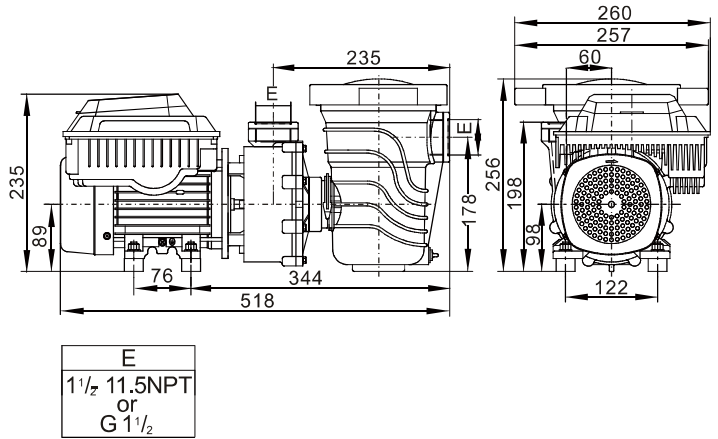
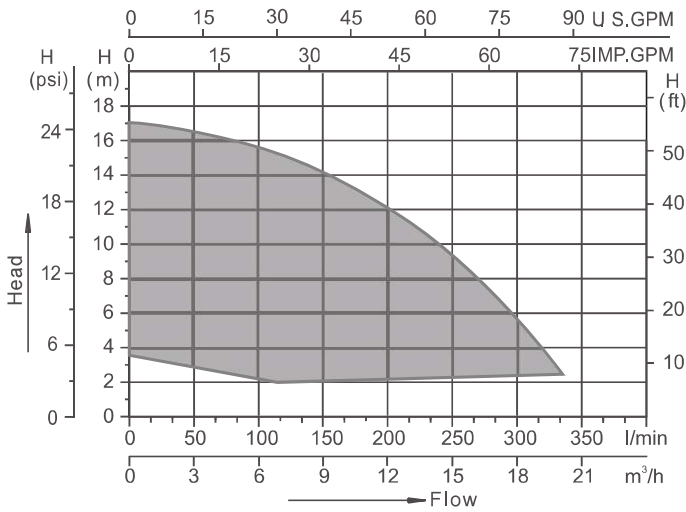

Relaax220-VS

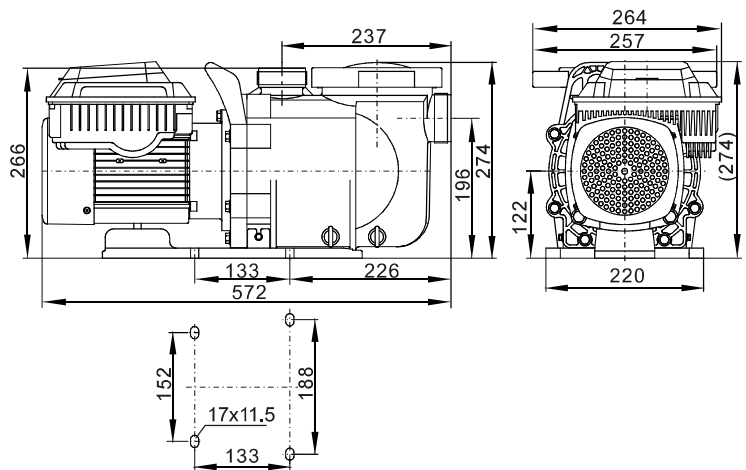
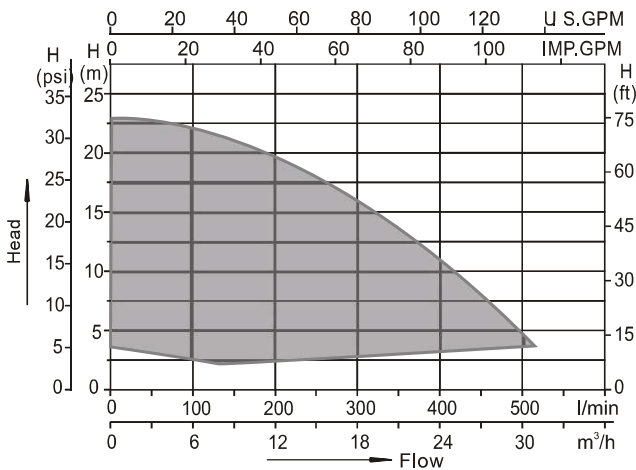

Relaax390-VS

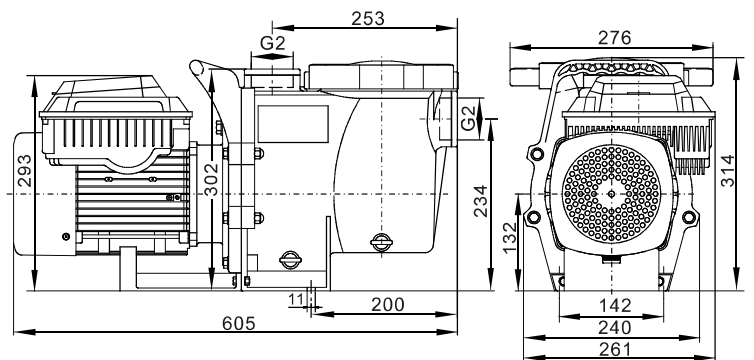
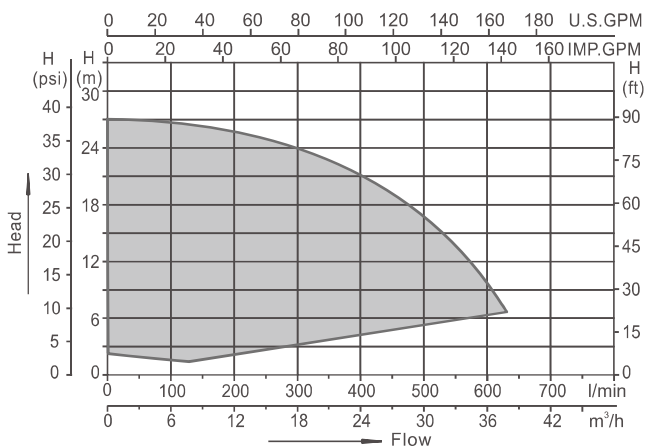

WARRANTY & CONTACT US

Warranty period:

① The warranty period is **3** years since the date of purchase.
(Note: 1 year for complete pump replacement, 2 years for parts replacement or maintenance.)

If you fill out the "Customer Information Registration Form" on our after-sales website: www.lingxiaopumps.com, the warranty period can be extended for another year.

② Warranty scope: natural damage occurred during normal use within the warranty period;

If one of the following situations occurs, it is not covered by the warranty:

- ✘ Damage caused by abnormal working environment or storage conditions;
- ✘ Damage caused by incorrect operation or use;
- ✘ Damage caused by repairing the product without our permission;
- ✘ Adding, modifying, and replacing parts of the product unauthorizedly;
- ✘ Man-made vandalism;
- ✘ Irreparable damage caused by force majeure and natural disasters;

Scope of maintenance:

① If the product cannot work normally under the specified conditions due to defects or errors in components, materials and manufacturing technology during the warranty period, the company will repair or replace it free of charge;

Remarks: The logistics cost of sending back to the company's repair center needs to be paid by the customer, and the company only pays the maintenance cost and the logistics cost of sending back to the customer.

Service Commitment:

① Within 30 days from the date of sale (according to the sales invoice or the date of order issuance), if the user is not satisfied with the quality of the product, and the product is not damaged by man-made or improper use, When the company confirms that the product cannot be repaired, the company will replace it for free;

② During the warranty period, if the product are naturally damaged under normal use, the company will provide free warranty.

PLEASE USE THE ORIGINAL BOX AND PROTECTION FOAM TO SEND THE PUMP BACK TO THE DESIGNATED ADDRESS IN ORDER TO AVOID DAMAGE DURING TRANSPORTATION.

Customer Service/ WhatsApp:
+1 647 800 0468
Email: Sales@lxpumps.cn
Website: www.lingxiaopumps.com

LINGXIAO®

All indicated LINGXIAO trademarks and logos are our property. Third parties own their registered and unregistered trademarks and logos. Since our products and services are continuously being improved, all rights are reserved to change specifications without prior notice.

LINGXIAO All rights reserved. This document is subject to change without notice.